

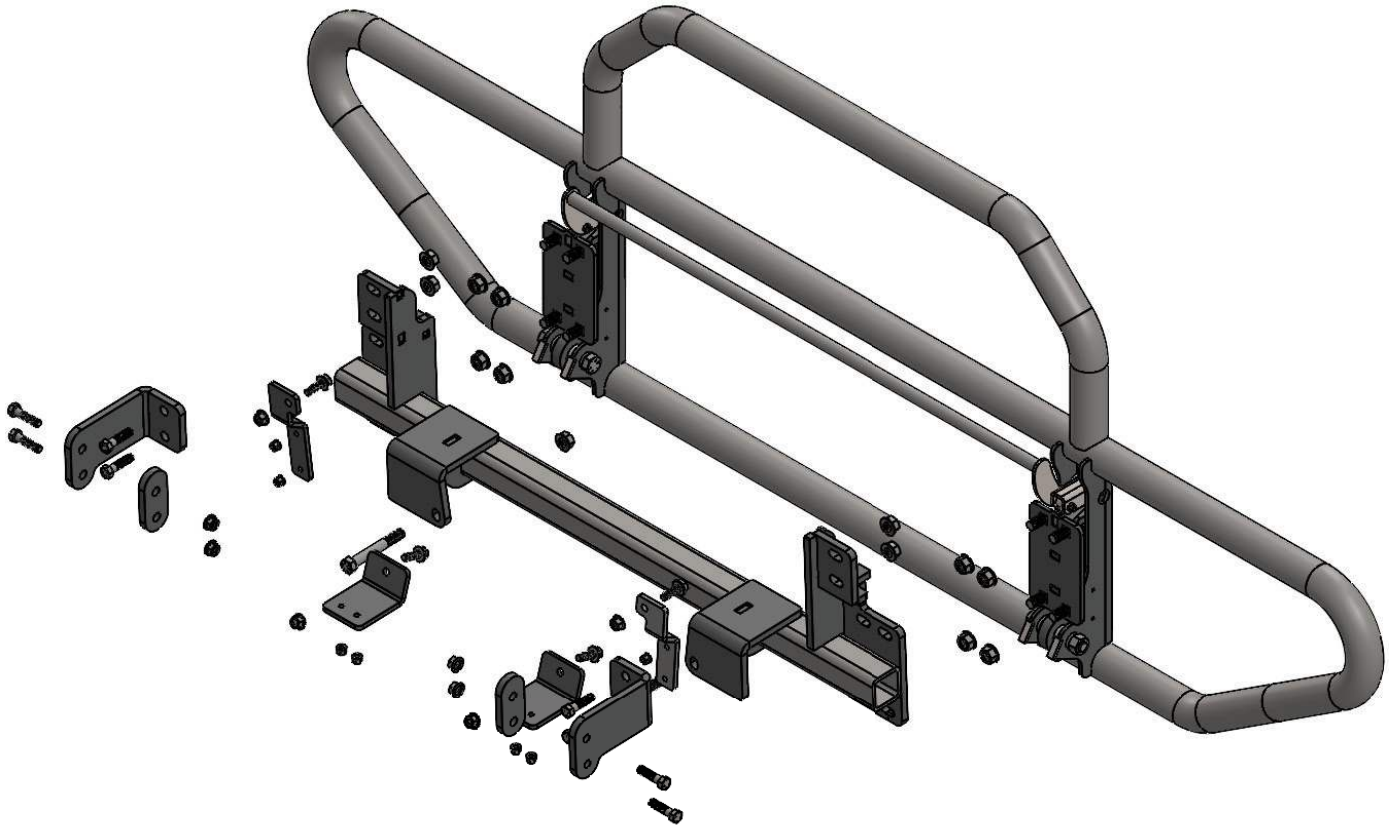

CALL: (888) 902-2777 FOR INSTALLATION QUESTIONS OR EMAIL: INFO@EX-GUARD.COM

MOUNTING INSTRUCTIONS - XG-17VHD MT INS REV1



SEE INSTALLATION INSTRUCTION GUIDE FOR INSTALL DETAILS



IMPORTANT!! Any Ex-Guard grille guard, bracket kit, or hardware must be used with corresponding Ex-Guard components. Use of any other product or brand with Ex-Guard products will immediately void the warranty provided by Ex-Guard Industries.

© THIS DRAWING IS THE PROPERTY OF EX-GUARD INDUSTRIES, INC. COPYRIGHT IS RESERVED BY THEM AND THE DRAWING ISSUED ON CONDITION THAT IT MUST NOT BE USED FOR ANY OTHER PURPOSE OTHER THAN FOR WHICH IT WAS SUPPLIED AND NOT TO BE COPIED, REPRODUCED, RETAINED OR DISCLOSED TO ANY UNAUTHORIZED PERSON EITHER WHOLLY OR IN PART WITHOUT THE CONSENT IN WRITING OF EX-GUARD INDUSTRIES INC.



CALL: (888) 902-2777 FOR INSTALLATION QUESTIONS OR EMAIL: INFO@EX-GUARD.COM

PARTS LIST - XG-17VHD REV1

BOLT KIT - XG-17VHD-BK REV1 & XG-BRK23

COMPATIBLE GUARDS

- Check <https://ex-guard.com/>

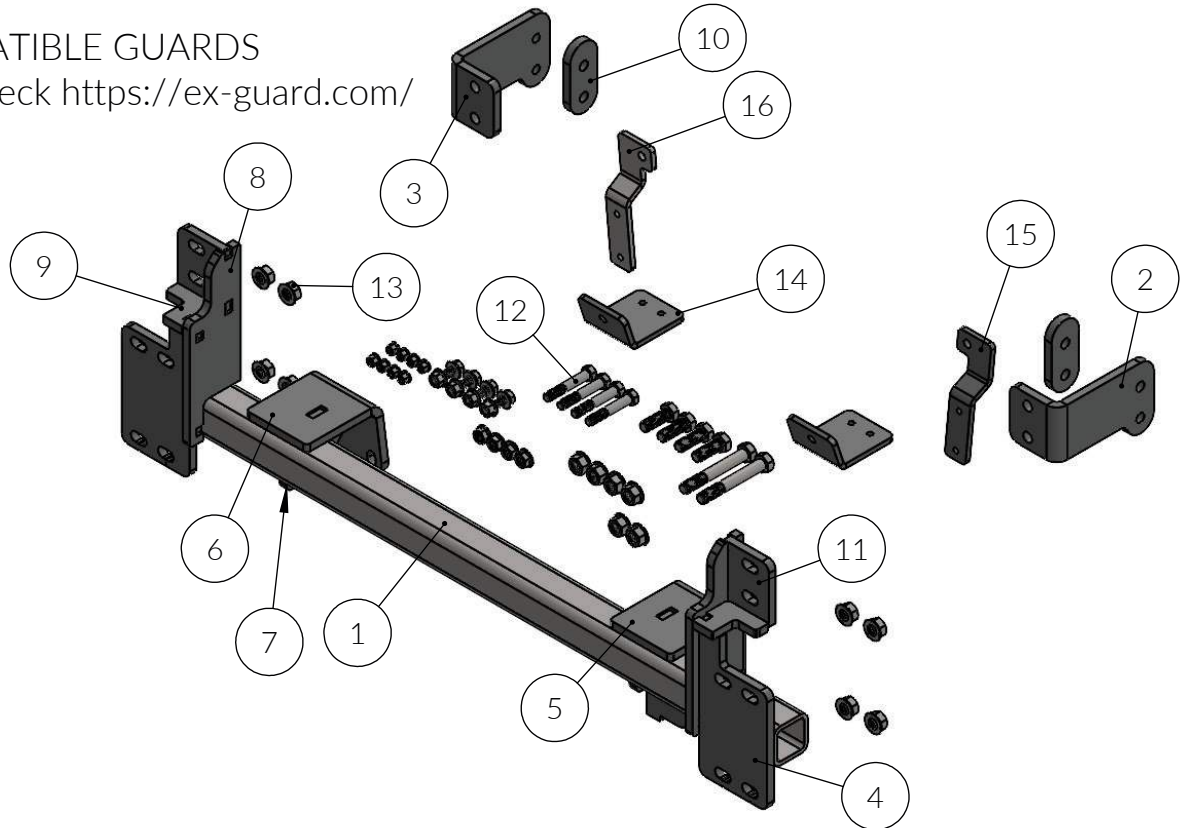

ITEM NO.	PART NUMBER	DESCRIPTION	QTY.
1	XG-17VHD-BR03	MOUNTING TUBE	1
2	XG-17VHD-BR01L	UPPER BRACKET DS	1
3	XG-17VHD-BR01R	UPPER BRACKET PS	1
4	XG-17VHD-BR02	MOUNTING PLATE	2
5	XG-17VHD-BR04L REV2	TUBE MOUNT (DS)	1
6	XG-17VHD-BR04R REV2	TUBE MOUNT (PS)	1
7	XG-17VHD-BR05 REV2	TUBE MOUNT GUSSET	3
8	XG-17VHD-BR06	GUSSET	2
9	XG-17VHD-BR07	UPPER SUPPORT GUSSET	2
10	XG-17VHD-BR08	SPACER	2
11	XG-17VHD-BR09	UPPER BOLT PLATE	2
12	XG-17VHD-BK REV1	BOLT KIT FOR XG-17VHD	1
13	XG-001-62-11FHHNL5ZY	5/8-11 FLANGE HEX NUT	8
14	XG-17VHD-BRBU1	MOUNT SUPPORT B FOR 2023 BUMPER MODEL	2
15	XG-17VHD-BRBU2DR	MOUNT SUPPORT FOR 2023 BUMPER MODEL (DS)	1
16	XG-17VHD-BRBU2PS	MOUNT SUPPORT FOR 2023 BUMPER MODEL (PS)	1

ATTENTION!! Any Ex-Guard grille guard, bracket kit, or hardware must be used with corresponding Ex-Guard components. Use of any other product or brand with Ex-Guard products will immediately void the warranty provided by Ex-Guard Industries.





XG-17VHD

INSTALLATION INSTRUCTIONS

INSTALLATION TOOLS

1/2" IMPACT DRIVER
5/8" IMPACT DRIVER
1/2" WRENCH 5/8" WRENCH
TORQUE WRENCH
5/8" DEEP SOCKET
1/2" DEEP SOCKET

INCLUDED WITH THE GUARD AND BRACKET

XG-17VHD BRACKET	
XG-17VHD-BR03 QTY: 1	
XG-17VHD-BR01L QTY: 1 XG-17VHD-BR01R QTY: 1	
XG-17VHD-BR02 QTY: 2	
XG-17VHD-BR04L QTY: 1 XG-17VHD-BR04R QTY: 1	
XG-17VHD-BR05 QTY: 2	
XG-17VHD-BR06 QTY: 2	
XG-17VHD-BR07 QTY: 2	
XG-17VHD-BR08 QTY: 2	
XG-17VHD-BRBU1 QTY:2	USE ONLY ON 2023 BUMPER STYLE
XG-17VHD-BRBU2DR QTY:1 XG-17VHD-BRBU2PS QTY: 1	USE ONLY ON 2023 BUMPER STYLE
XG-17VHD-BR09 QTY: 2	
HARDWARE	

STEP 1: COLLECT THE BRACKET AND THE NECESSARY TOOLS SHOWN BELOW

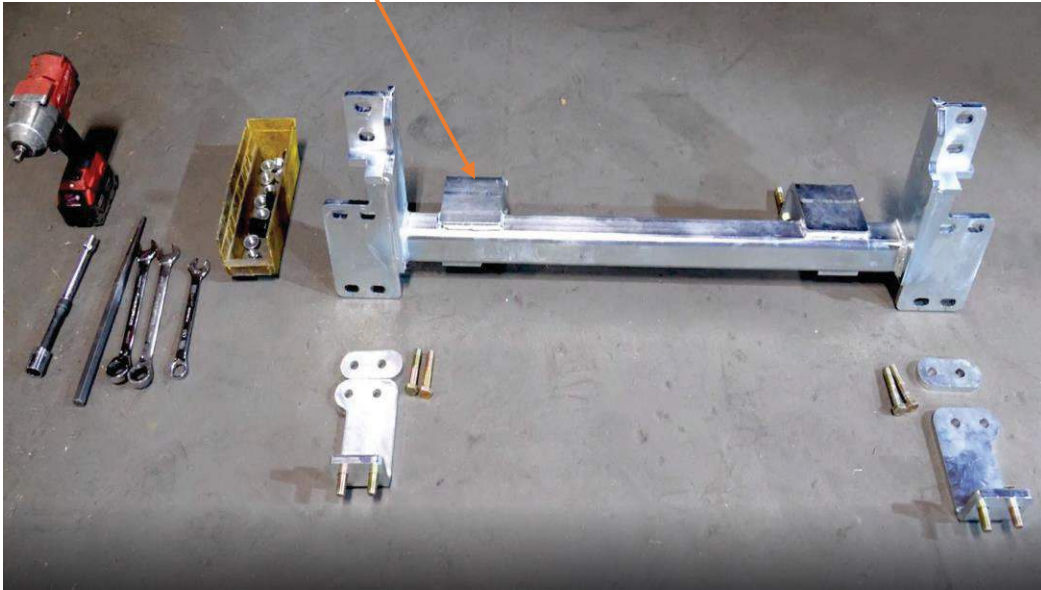

STEP 2: REMOVE THE BOTLS AND
HARDWARE LOCATED HERE

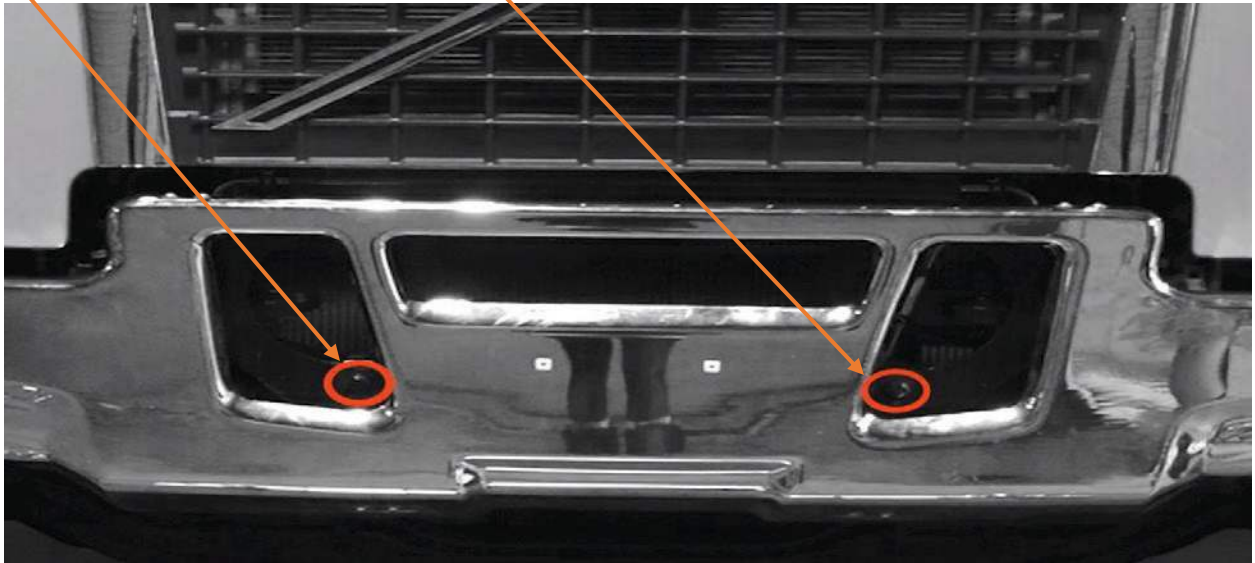

STEP 3: LOOK INSIDE THE TRUCK AND
REMOVE THE BOTLS SHOWN BELOW

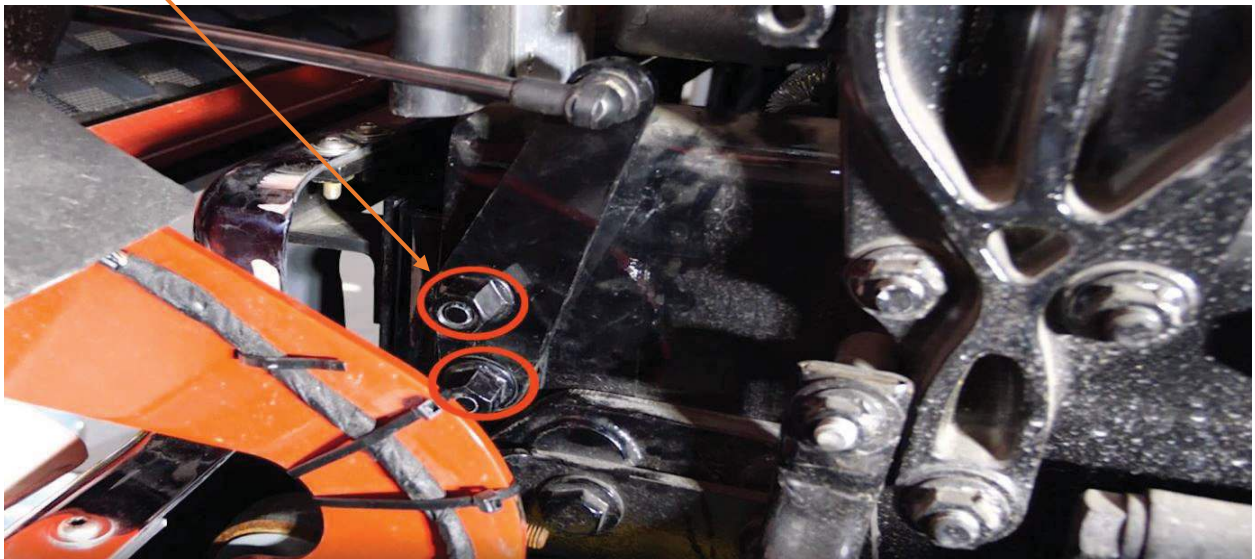

FRONT VIEW OF 2023 MODEL



The above style bumper is the only style that needs the bumper removed for proper bracket install.

To remove the bumper: remove the 4 bolts shown below



Also remove the 4 bolts shown below



Lift the truck hood and remove the bolt on the left and right side of the bumper. See below:



After the bumper is removed
Remove the below bracket components
Replace bracket components with provided parts:
XG-17VHD-BRBU1
XG-17VHD-BRBU2DR
XG-17VHD-BRBU2PS

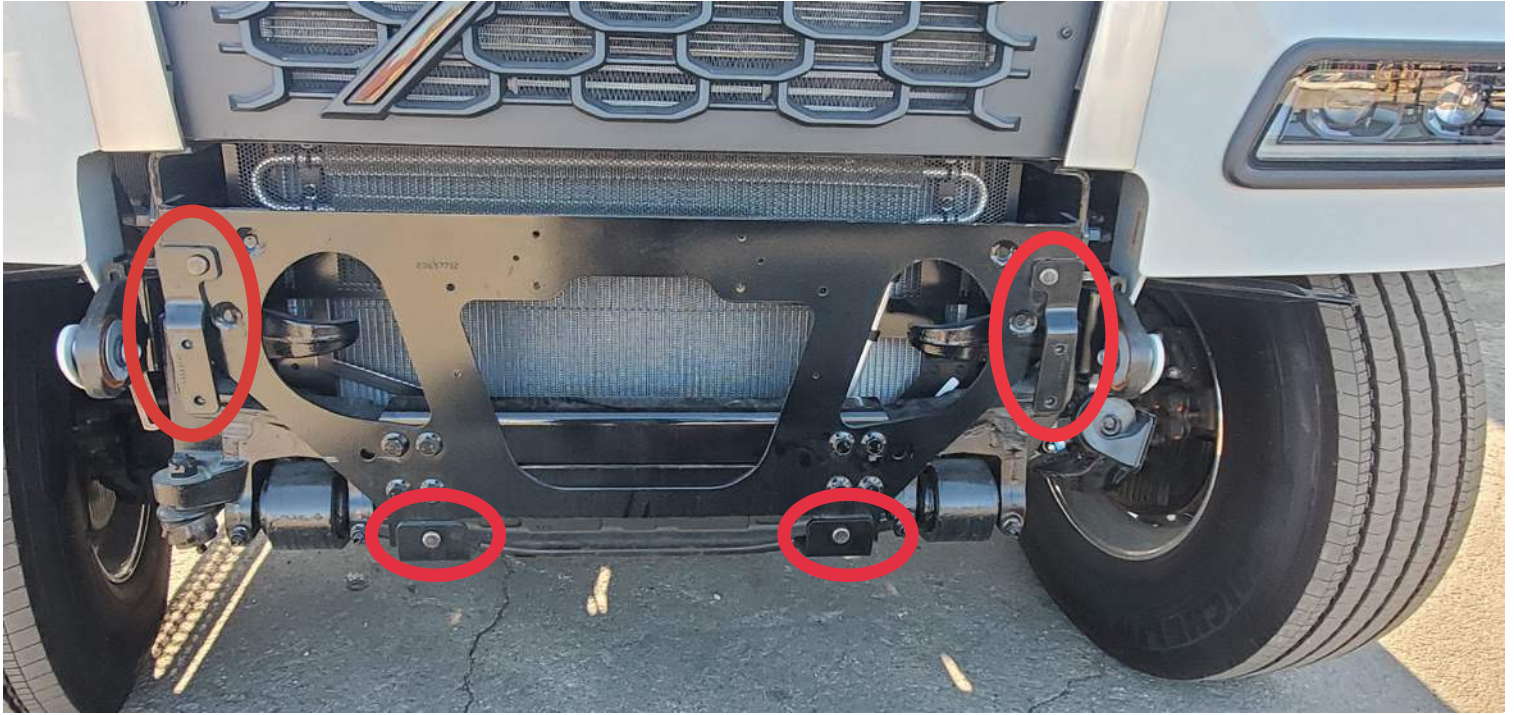

Once the above is complete, move to step 4.

STEP 4: INSERT THE BOLT PROVIDED
IN THE XG-17VHD-BR01L & R
BRACKET



STEP 5: COLLECT THE SPACER PLATE
SHOW BELOW XG-17VHD-BR08

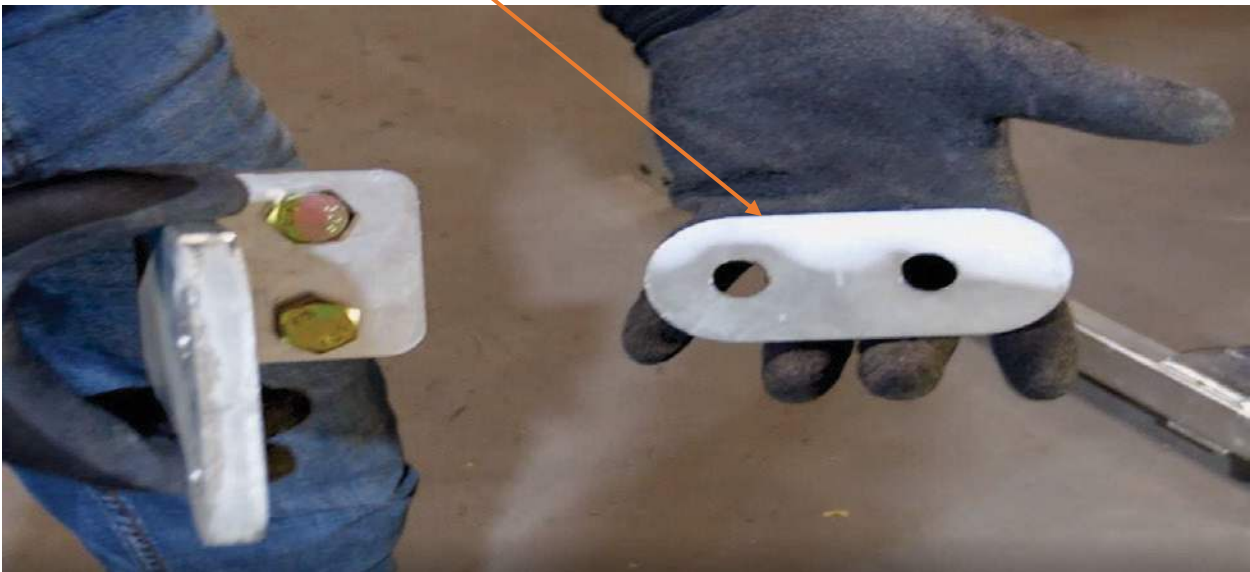

STEP 6: INSERT THE PLATE USING THE
HHCS $\frac{1}{2}$ "-4.00 LONG BOLT SHOWN
BELOW INSIDE THE TRUCK



STEP 7: INSERT THE MOUNTING BRACKET XG-17VHD-BR01L & R, ONTO THE PLATE AS SHOWN

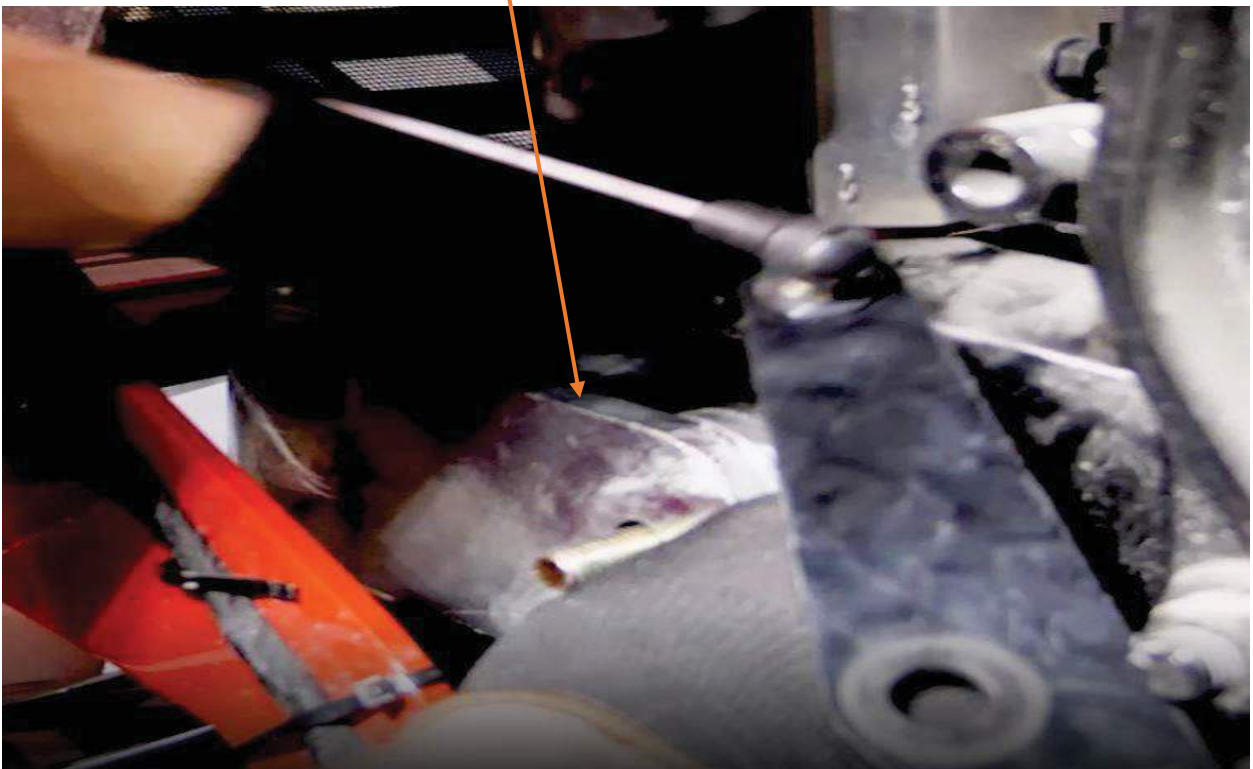
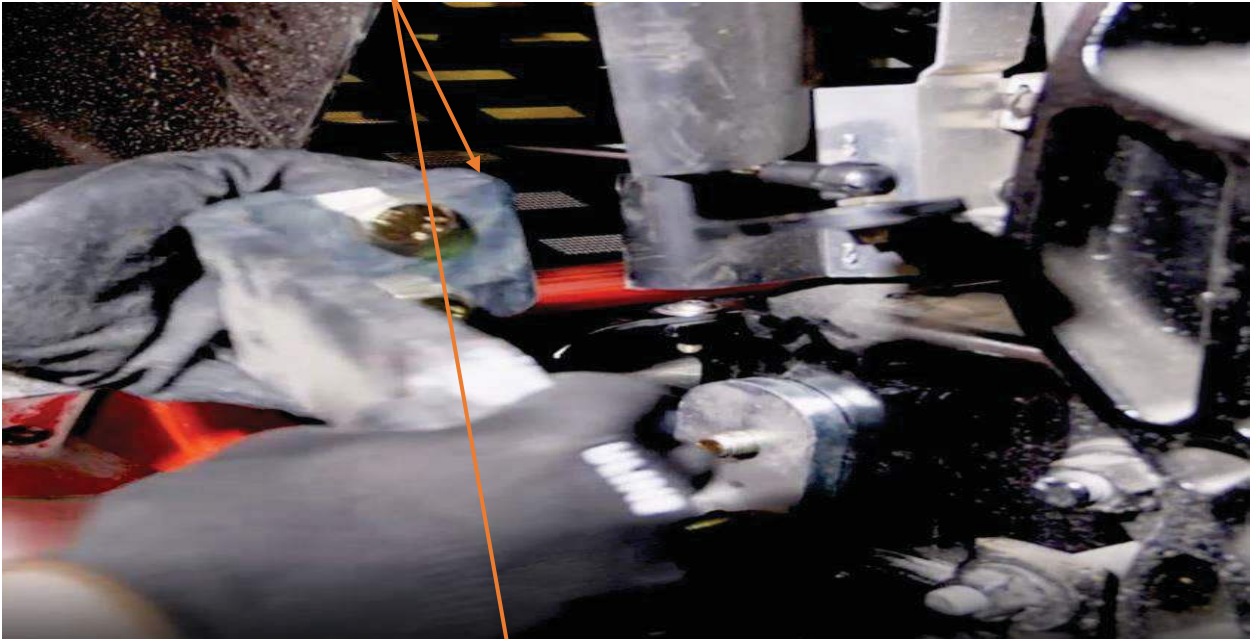

STEP 8: INSERT THE LOCKING PLATE
PROVIDE WITH THE TRUCK TO
INSURE SECURE POINT.

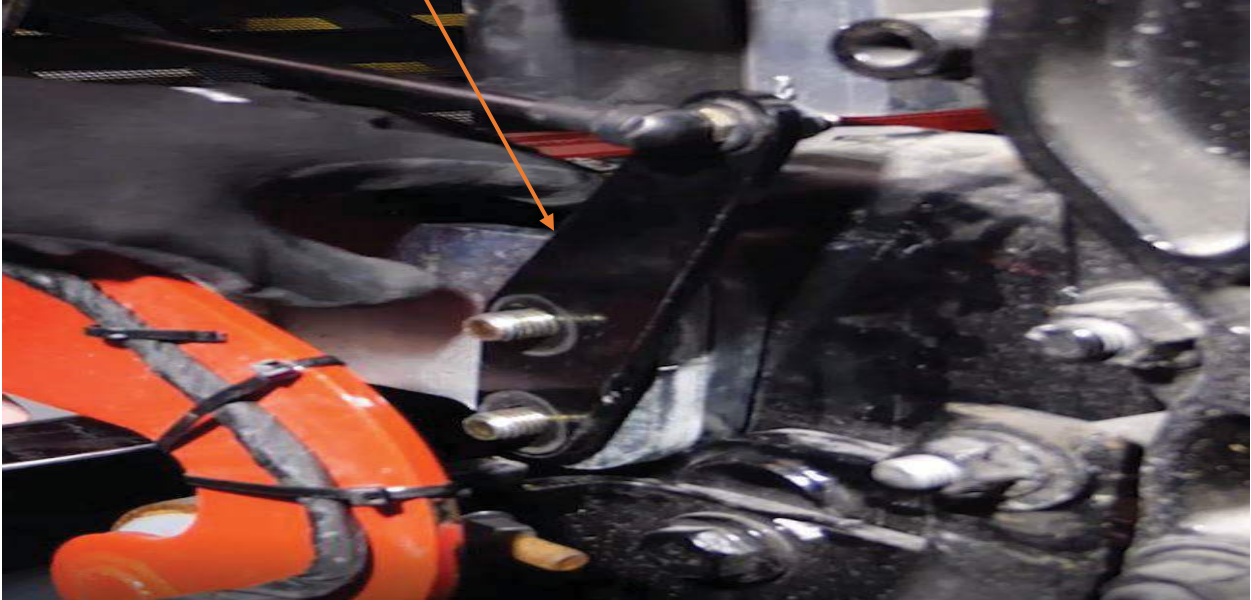

STEP 9: INSERT THE NUTS PROVIDED
TO LOCK AND SECURE THE BRACKET

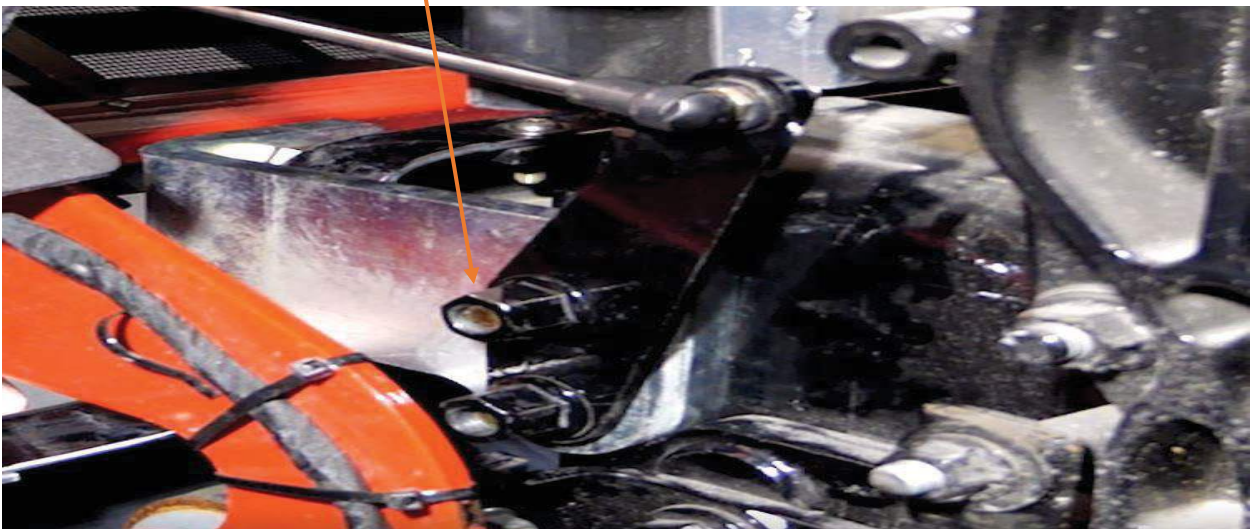

STEP 10: LOCATE THE BODY OF THE XG-17VHD BRACKET AND INSERT THE BOLTS PROVIDED AS SHOWN



STEP 11: INSERT THE BRACKET USING THE PROVIDED BOLT ONTO THE TRUCK



STEP 12: USING THE PROVIDED HARDWARE, TIGHTEN UP THE BOTTOM NUT AS SHOWN



STEP 13: INSERT THE TOP NUTS AS SHOWN

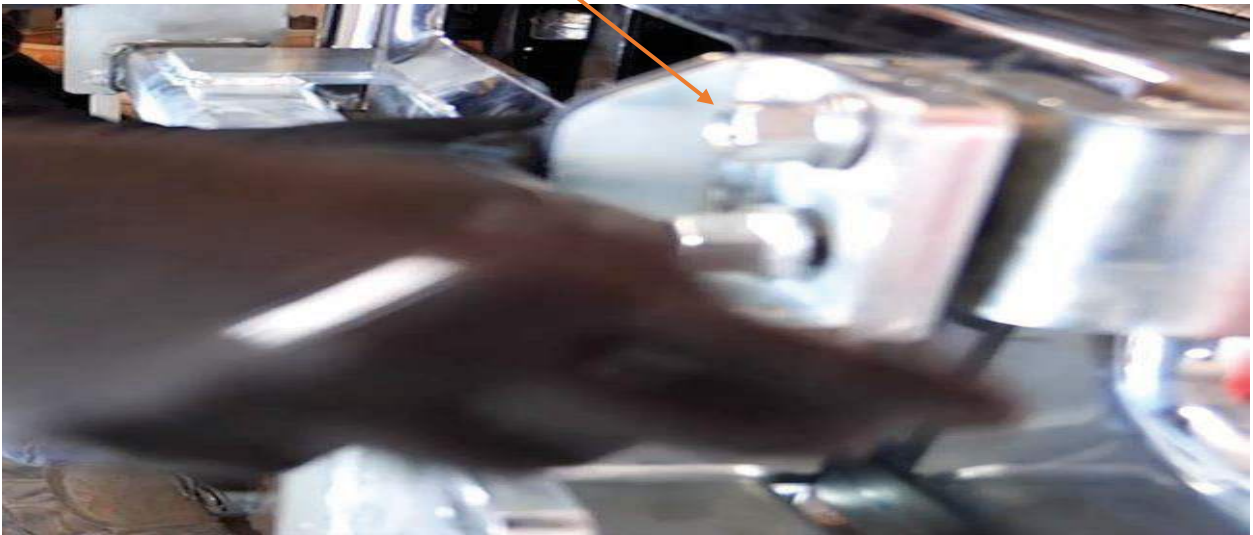

STEP 14: USING AN IMPACT, MAKE SURE TO TORQUE ALL OF THE BOLTS AND HARDWARE



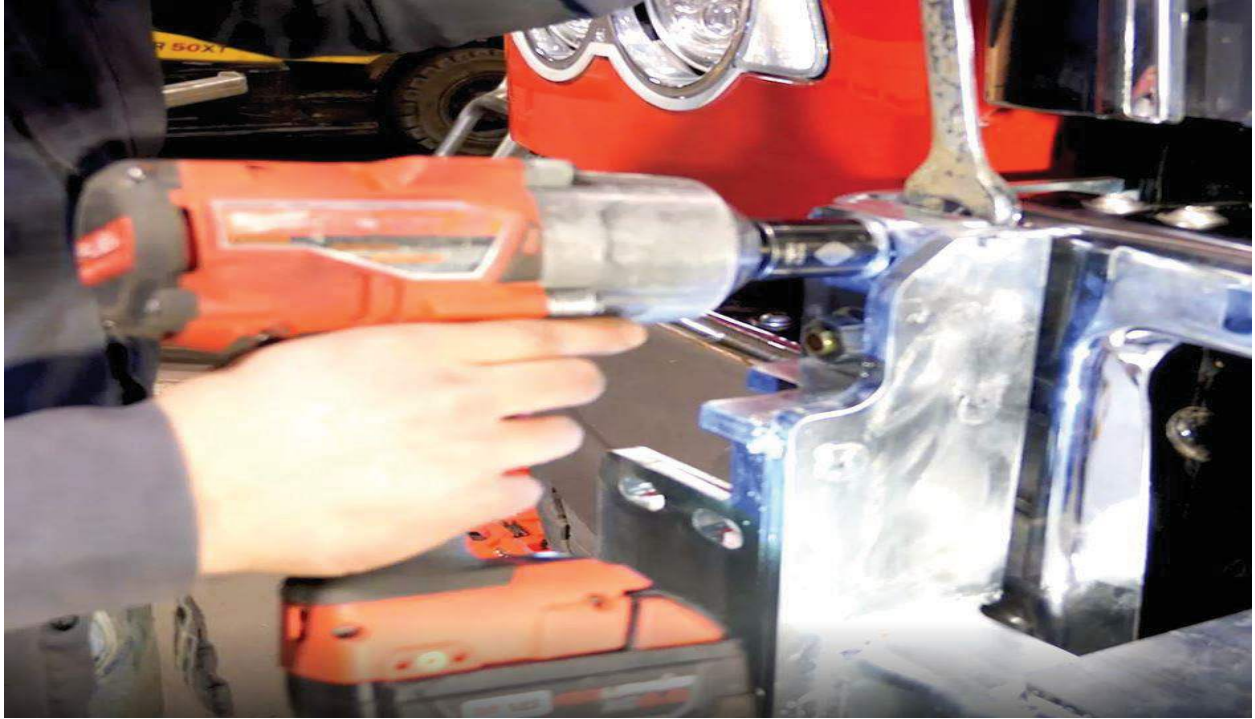

Before step 15, if truck has the new 2023 bumper style.
Install bumper back on truck and then proceed to step 15.

STEP 15: MOUNT THE GUARD PROVIDED USING THE BOLTS INSERTS

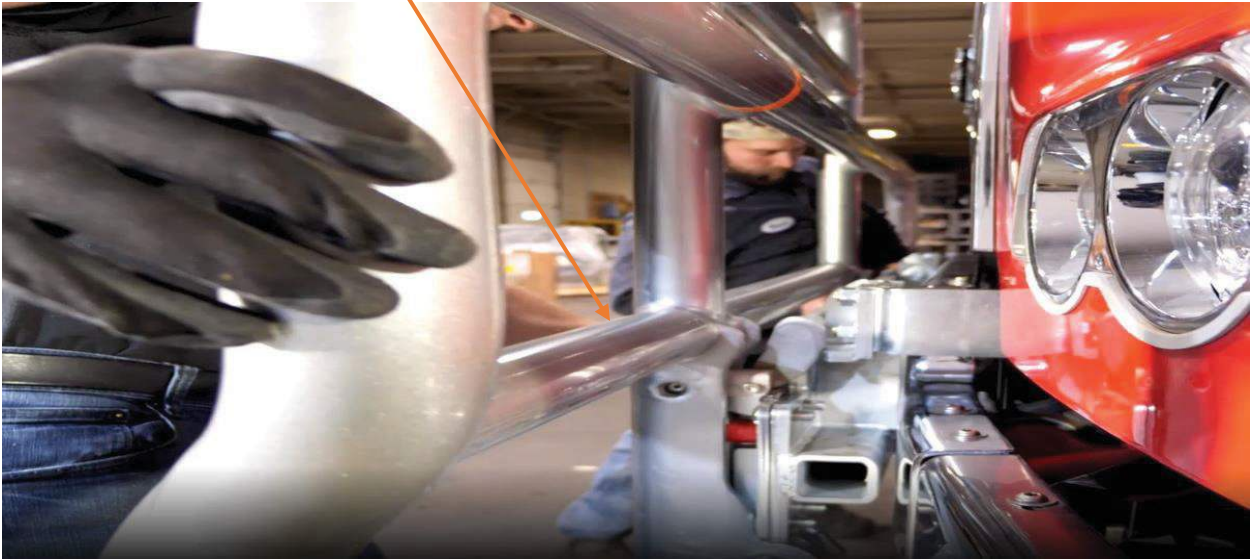

STEP 16: TIGHTEN AND TORQUE THE REMAINING HARDWARE



DRIVE SAFE